

**Technical specification:**

Rated voltage: IEC 60664-1	300 V
Overvoltage category: IEC 60664-1	2
Overvoltage: IEC 60664-1	2,7 kV
Current rating: IEC 60512-3 at 40°C	12 A
Insulation resistance: IEC 60512	>=100 MΩ
Pollution degree: IEC 60664-1	3/2
Degree of protection: IEC 60529	IP 67, in mated condition
Temperature range: IEC 60664-1	-30°C ... +75°C
Mating cycles: IEC 60512-9a	>=100

**Materials:**

Contact:	CuZn
Contact plating:	Nickel, gold plated
Contact carrier:	TPU, UL 94
Sealing:	FPM
Socket housing:	CuZn, nickel plated
Grouting:	Polyurethane-resin, UL 94

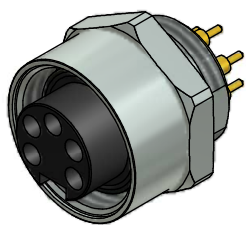
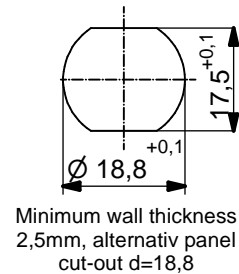
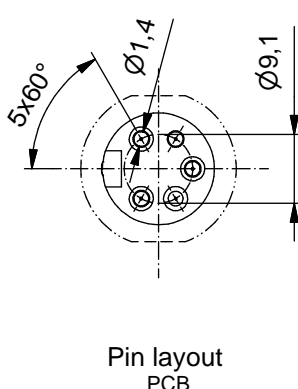
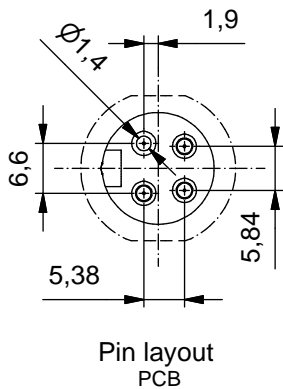
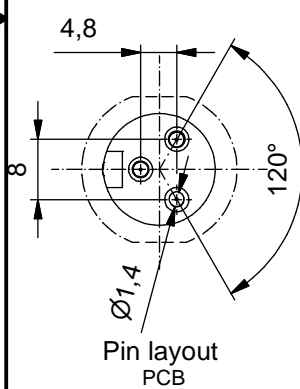
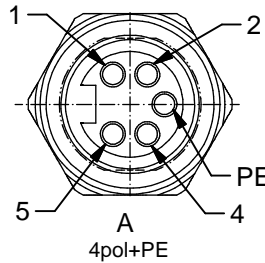
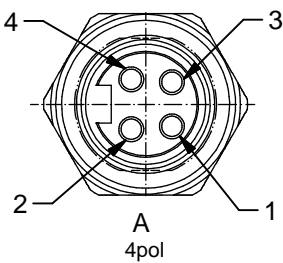
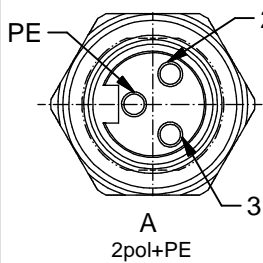

Part no:	Description:	Pos	L
41-40045	SAL - 7/8 - FK2PE - P10 - 11	3	10mm
41-40046	SAL - 7/8 - FK4 - P10 - 11	4	10mm
41-40047	SAL - 7/8 - FK4PE - P10 - 11	5	10mm

DO NOT ALTER CAD DRAWING BY HAND  
Directive 2002/95/EC RoHS compliant

Index: c 18.10.11 fro Ä4130  
Temperatur changed

dim. in mm

date	name
drawn 08.12.08	Fromm
appd. 08.12.08	W.Schmidt

general tolerance: 0 ± 0,50mm  
0,0 ± 0,25mm  
0,00 ± 0,10mm

THIS DRAWING MAY NOT BE COPIED OR REPRODUCED IN ANY WAY, AND MAY NOT BE PASSED ON TO A THIRD PARTY WITHOUT WRITTEN PERMISSION. OWNERSHIP AND COPYRIGHT OF CONEC GmbH

title:  
**Female socket 7/8" with dip solder, frontmounting, PG11**

dwg no:  
**41K1A389**

part no:

**CONEC**®