

Assembly Instructions for - 38723

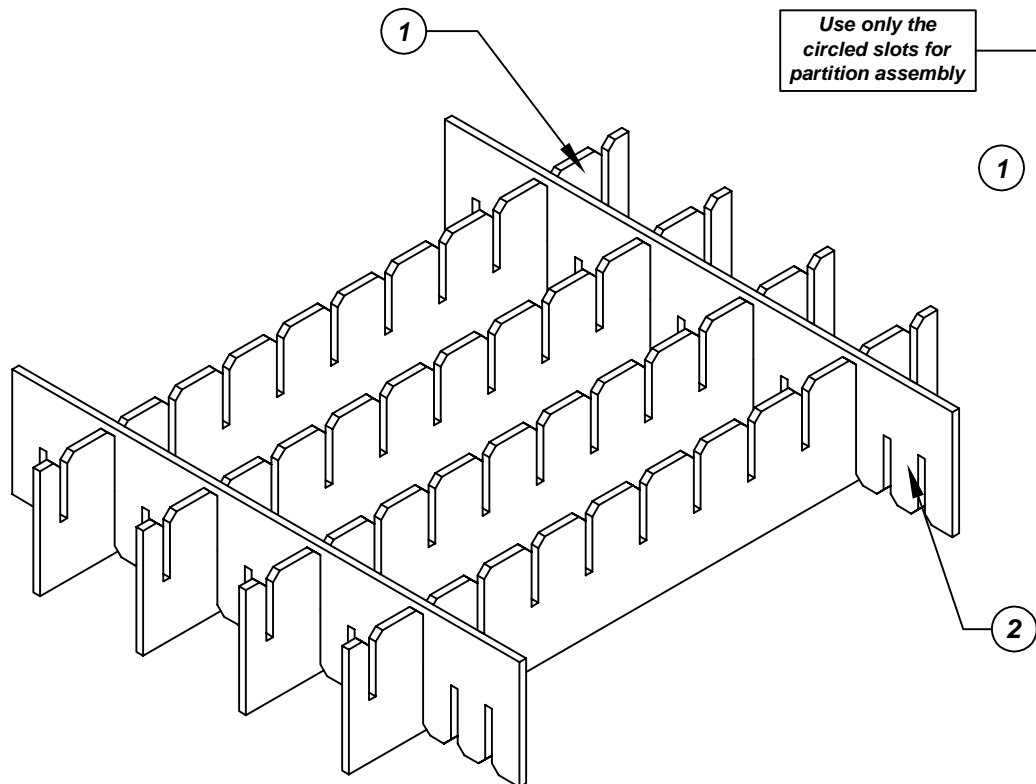

Use only the circled slots for partition assembly

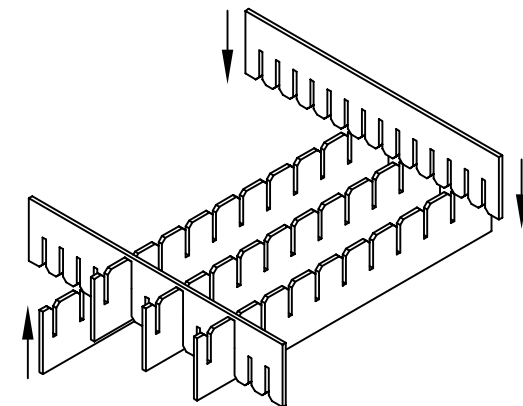
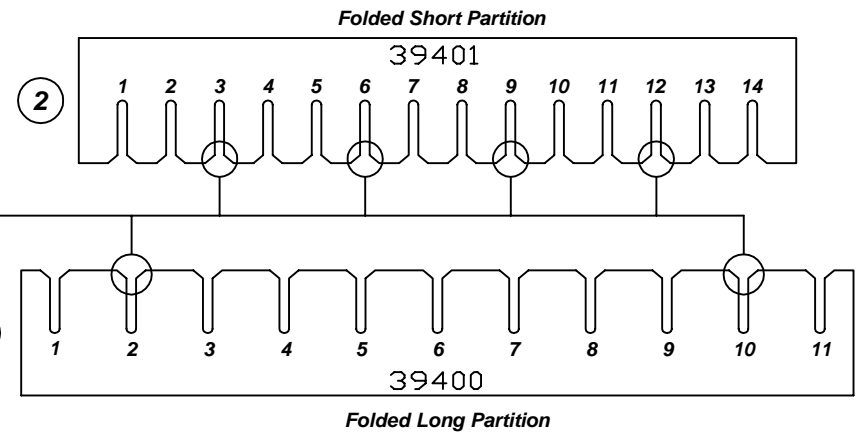

Made in America

F/N ①	Part # 39400	Dimensions: 8-3/16" x 21-3/4"	Description: Adjustable Long Partition	Qty: 4
F/N ②	Part # 39401	Dimensions: 8-3/16" x 18-3/4"	Description: Adjustable Short Partition	Qty: 2

38723 - 5 Cell Inplant Handler Cell Size - 4" x 15-3/4" x 3-1/2"

Notes:
For use with the following storage container & lid:
37530 - Storage Container
37557 - Lid

PROTEKTIVE PAK
13520 MONTE VISTA AVENUE, CHINO, CA 91710
PHONE (909) 627-2578, FAX (909) 363-7331
ProtektivePak.com



DRAWING NUMBER
IPH-38723

DATE
August
2011