

NOTE:
 1. MATERIAL:
 HOUSING: THERMOPLASTIC POLYESTER WITH GLASS FIBER FILLED,
 UL 94V-0, COLOR: BLACK.
 COVER: THERMOPLASTIC POLYESTER WITH GLASS FIBER FILLED,UL 94V-0, COLOR: BLACK.
 CONTACT: PHOSPHOR BRONZE
 FRONT SHIELD: BRASS
 REAR SHIELD: BRASS
 GROUND FINGER: BRASS
 2. FINISH:
 CONTACT :15 MICROINCH GOLD PLATED IN CONTACT AREA.
 150 MICROINCH-250 MICROINCH TIN PLATED ON SOLDER TAILS.
 50 MICROINCH NICKEL UNDERPLATED OVER ALL.
 FRONT SHIELD: 100 MICROINCH TIN PLATED ON ENTIRE WITH
 50 MICROINCH NICKEL UNDERPLATED OVER ALL.
 REAR SHIELD: NICKEL PLATED WITH 120 MICROINCH MINIMUM,
 GROUND FINGER:100 MICROINCH TIN PLATED ON ENTIRE WITH
 50 MICROINCH NICKEL UNDERPLATED OVER ALL.
 3. PRODUCT SPECIFICATION:REFER TO PS-67857-002
 4. PACKAGING: REFER TO PK-67857-002
 5. TEST SUMMARY: REFER TO TS-67857-002
 6. LEAD-FREE AND ROHS COMPLIANT PRODUCT

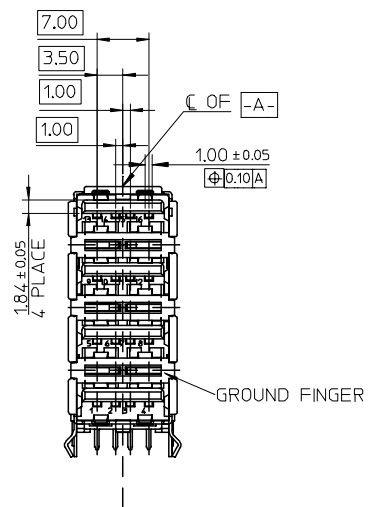

REVISED EC NO: SH2007-0796 2007/06/01 DRW:EKAO01 2007/06/01 CHKD: 2007/06/01 APPR:WWSCHANG 2007/06/01	DESCRIPTION	QUALITY SYMBOLS	GENERAL TOLERANCES (UNLESS SPECIFIED)	DIMENSION STYLE	SCALE	DESIGN UNITS	THIRD ANGLE PROJECTION
		▽=0 ∇=0	mm INCH	MM ONLY	1.5:1	METRIC	
			4 PLACES ± --- ± ---	DRAWN BY DEQUAN	DATE 05/04/13	TITLE USB 4 STACKS	
			3 PLACES ± --- ± ---	CHECKED BY ERIC KAO	DATE 05/04/13	MOLEX INCORPORATED	
			2 PLACES ± 0.25 ± ---	APPROVED BY WWSCHANG	DATE 05/04/13	DOCUMENT NO. SD-67857-002	SHEET NO. 1 OF 2
			1 PLACE ± 0.25 ± ---	MATERIAL NO.		THIS DRAWING CONTAINS INFORMATION THAT IS PROPRIETARY TO MOLEX INCORPORATED AND SHOULD NOT BE USED WITHOUT WRITTEN PERMISSION	
			ANGULAR ± 3 °	SEE TABLE			
			DRAFT WHERE APPLICABLE MUST REMAIN WITHIN DIMENSIONS	SIZE A3			

67857-0011	LEAD FREE
Molex P/N	NOTE

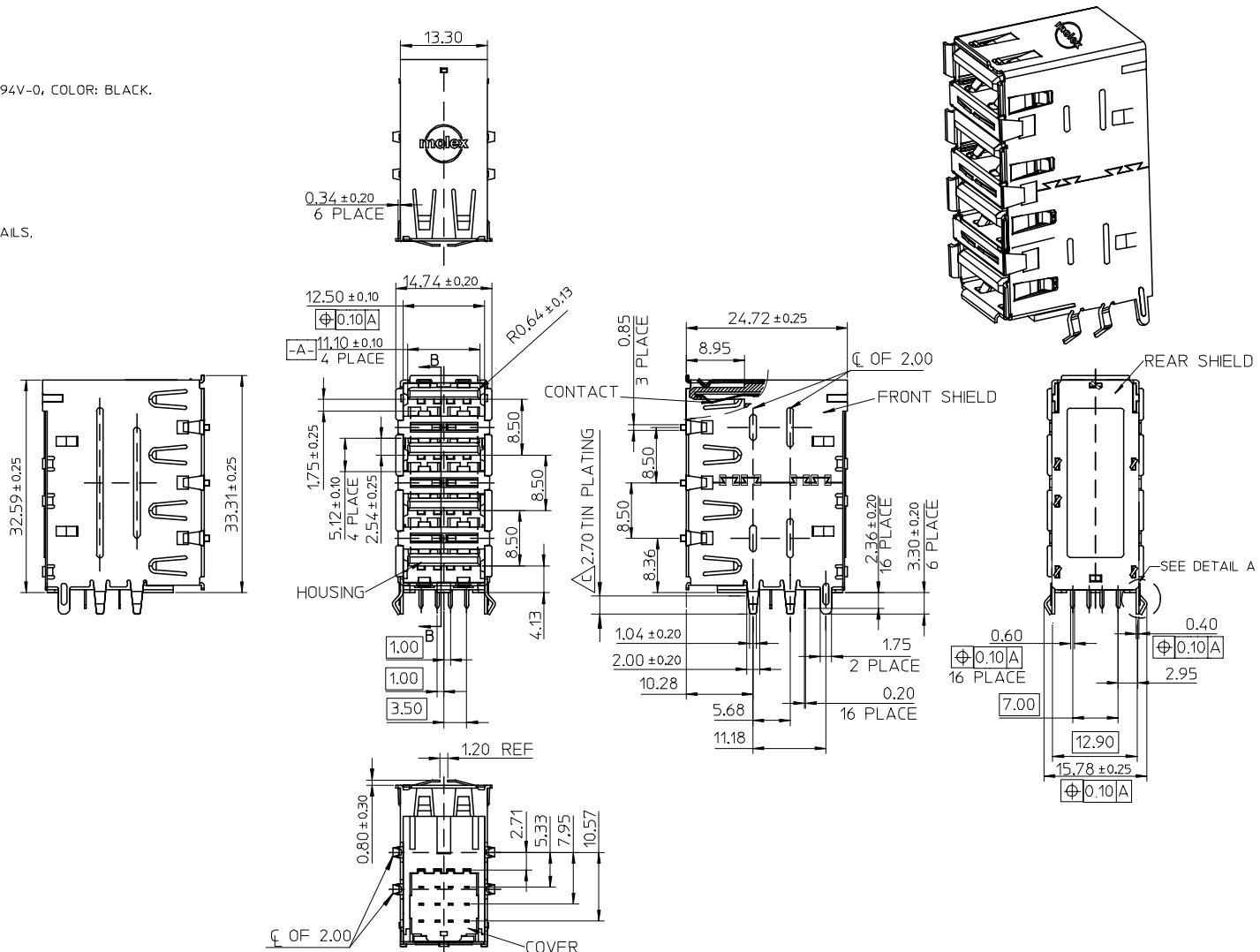
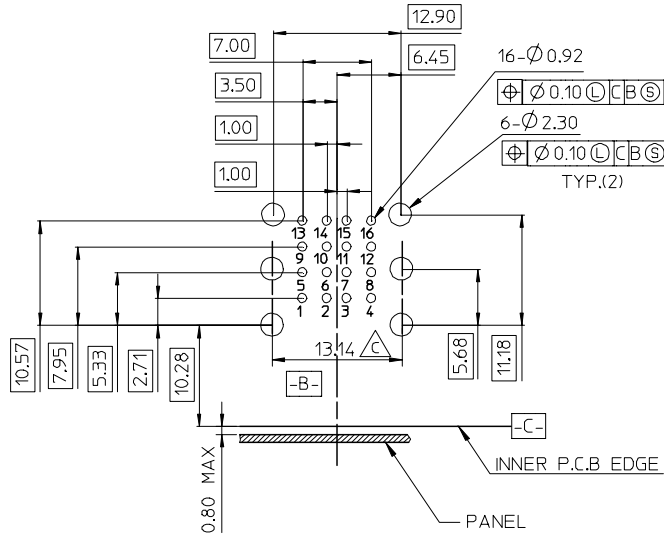

RECOMMENDED P.C.B. LAYOUT (1) (THICKNESS=1.6MM)
(GENERAL TOLERANCE: ±0.05MM)

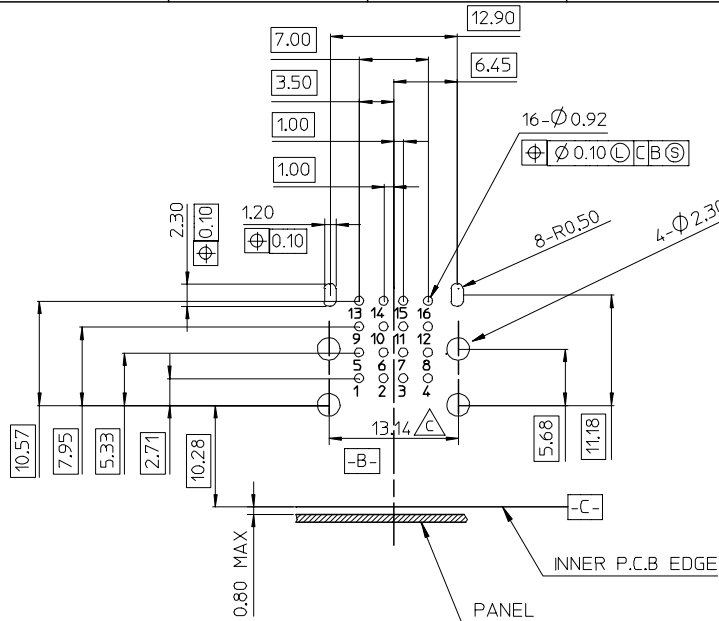

RECOMMENDED P.C.B. LAYOUT (2) (THICKNESS=1.6MM)
(GENERAL TOLERANCE: ±0.05MM)

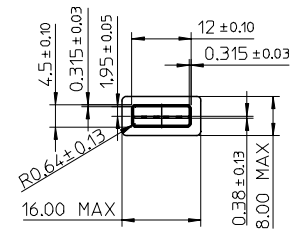
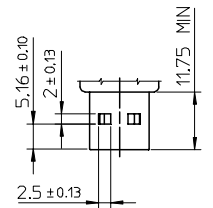

USB CABLE DRAWING

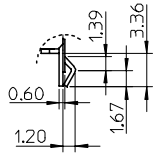

DETAIL A
SCALE 2:1

REVISED EC NO: SH2007-0796 DRW: EKA001 CHKD: APPR: WWSCHANG 2007/06/01 2007/06/01 2007/06/01	QUALITY SYMBOLS ▽=0 ▽=0	GENERAL TOLERANCES (UNLESS SPECIFIED)		DIMENSION STYLE MM ONLY		SCALE 1:1	DESIGN UNITS METRIC	THIRD ANGLE PROJECTION			
		4 PLACES ± --- ± ---	3 PLACES ± --- ± ---	2 PLACES ± 0.25 ± ---	1 PLACE ± 0.25 ± ---	DRAWN BY DEQUAN	DATE 05/04/13	TITLE USB 4 STACKS			
		ANGULAR ± 3 °				CHECKED BY ERIC KAO	DATE 05/04/13	MOLEX INCORPORATED			
		DRAFT WHERE APPLICABLE MUST REMAIN WITHIN DIMENSIONS				APPROVED BY WWSCHANG	DATE 05/04/13	MATERIAL NO. SEE TABLE	DOCUMENT NO. SD-67857-002	SHEET NO. 2 OF 2	