

## SPECIFICATION

Part No.	:	WSA.2400.A.101151
Product Name	:	Phoenix WSA.2400 Bluetooth I-Bar 2.4GHz Antenna
Features	:	Wi-Fi/WLAN 2.4GHz Adhesive Mount Antenna 1M RG-174 cable with RP-SMA(M) connector Ingress Protection Rating IP65 Adhesive Mount Low Profile for Ease of Installation Fully Customizable Cable and Connector 105*30*7.7mm RoHS Compliant



## 1. Introduction

The Phoenix WSA.2400 I-Bar antenna is a robust and low profile antenna operating on the 2.4GHz band for Wi-Fi, Bluetooth, and ISM applications.

The Phoenix has a slim-line design, which allows for covert and convenient installation in any application, while its omnidirectional radiation pattern and 2dBi gain ensure constant reception and transmission. It is manufactured and tested in a TS16949 first tier automotive approved facility and has undergone full PPAP design, reliability and quality audits.

The Phoenix is especially suited for applications such as:

- First-tier automotive applications
- Telematics

The Phoenix has exceptional industry performance characteristics considering its very low profile (just 7.7mm) and compact size (105\*30mm).

This UV resistant antenna is designed to be mounted on glass or plastic but not on metal. It comes with strong 3M double-sided adhesive for a permanent and secure fix to your application.

Cable lengths, types and connectors are fully customizable.

## 2. Specification

Wi-Fi		
Frequency	2400~2500MHz	
Efficiency (%)		
In free space	0.3m	72.38
	1m	57.37
	2m	40.97
	3m	29.31
	5m	15.19
On glass	0.3m	73.09
	1m	57.94
	2m	41.36
	3m	29.59
	5m	15.34
On the 2mm ABS	0.3m	71.10
	1m	56.37
	2m	40.24
	3m	28.79
	5m	14.92
Average Gain(dBi)		
In free space	0.3m	-1.40
	1m	-2.41
	2m	-3.88
	3m	-5.33
	5m	-8.19
On glass	0.3m	-1.36
	1m	-2.37
	2m	-3.83
	3m	-5.29
	5m	-8.14
On the 2mm ABS	0.3m	-1.48
	1m	-2.49
	2m	-3.95
	3m	-5.41
	5m	-8.26

Peak Gain(dBi)		
In free space	0.3m	2.18
	1m	1.18
	2m	-0.22
	3m	-1.72
	5m	-4.52
On glass	0.3m	4.67
	1m	3.67
	2m	2.17
	3m	0.77
	5m	-2.13
On the 2mm ABS	0.3m	3.21
	1m	2.21
	2m	0.74
	3m	-0.69
	5m	-3.56
Return loss	< -10 dB	
VSWR	≤ 2:1	
Impedance	50Ω	
Polarization	Linear	
Radiation Pattern	Omnidirectional	
Input Power	2W	
<b>MECHANICAL</b>		
Dimensions	105*30*7.7mm	
Casing	PC/ABS	
Connector	RP-SMA(M)	
Cable	RG-174	
Waterproof	IP65	
Weight	50g	
<b>ENVIRONMENTAL</b>		
Temperature Range	-40°C to 85°C	
Humidity	Non-condensing 65°C 95% RH	

## 3. Antenna Characteristics

### 3.1 Antenna Test Setup

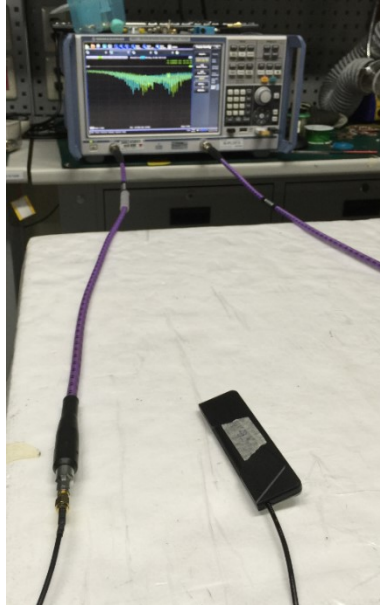

In free space

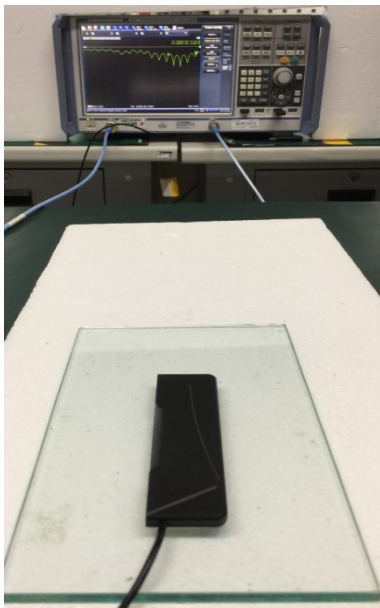

On glass

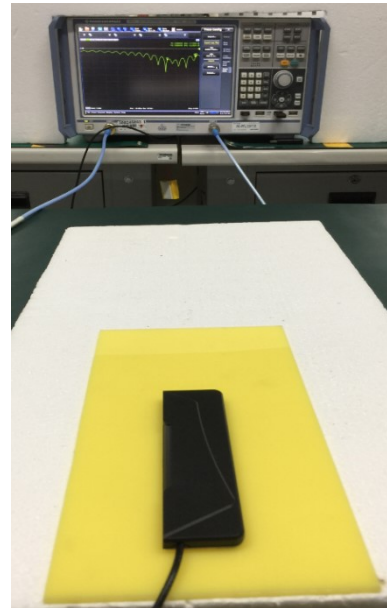

On the 2mm ABS

### 3.2 Return Loss

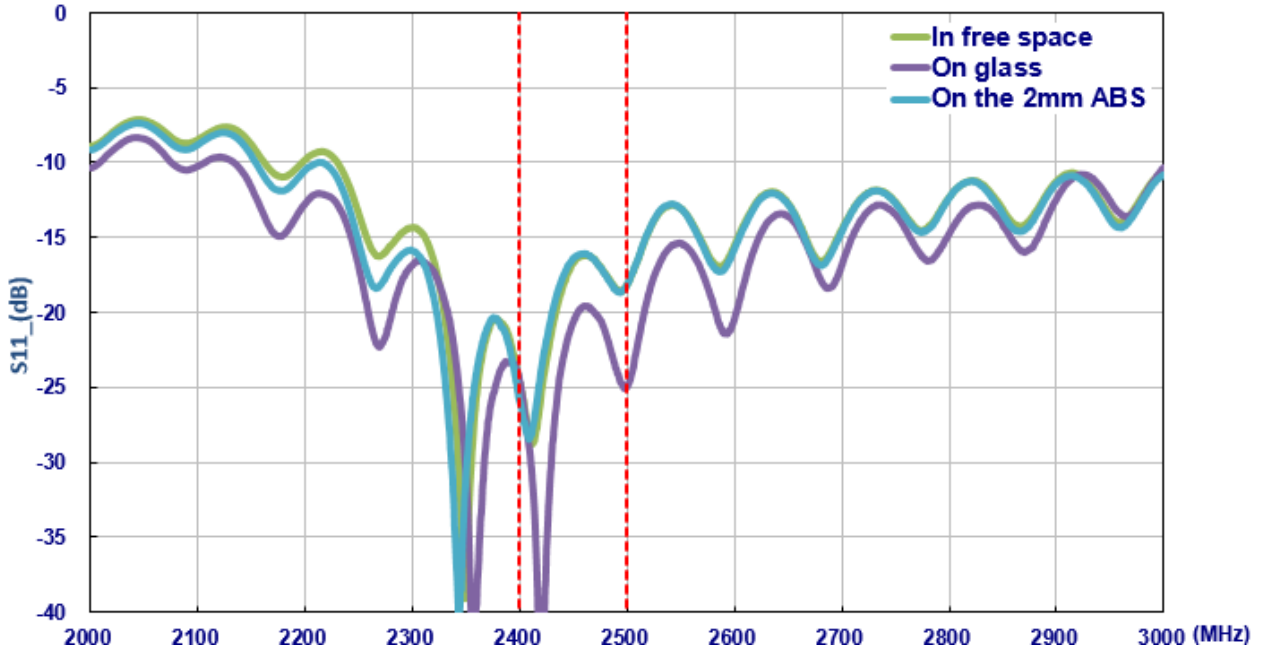

### 3.3 Efficiency

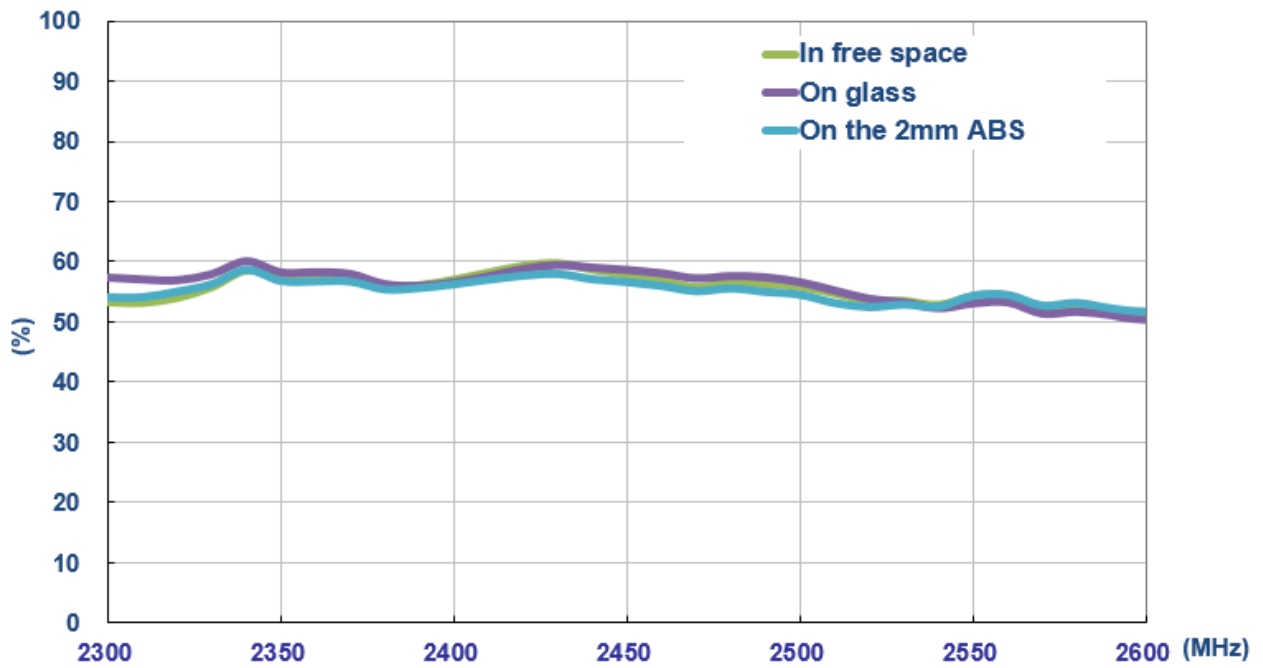

### 3.4 Peak Gain

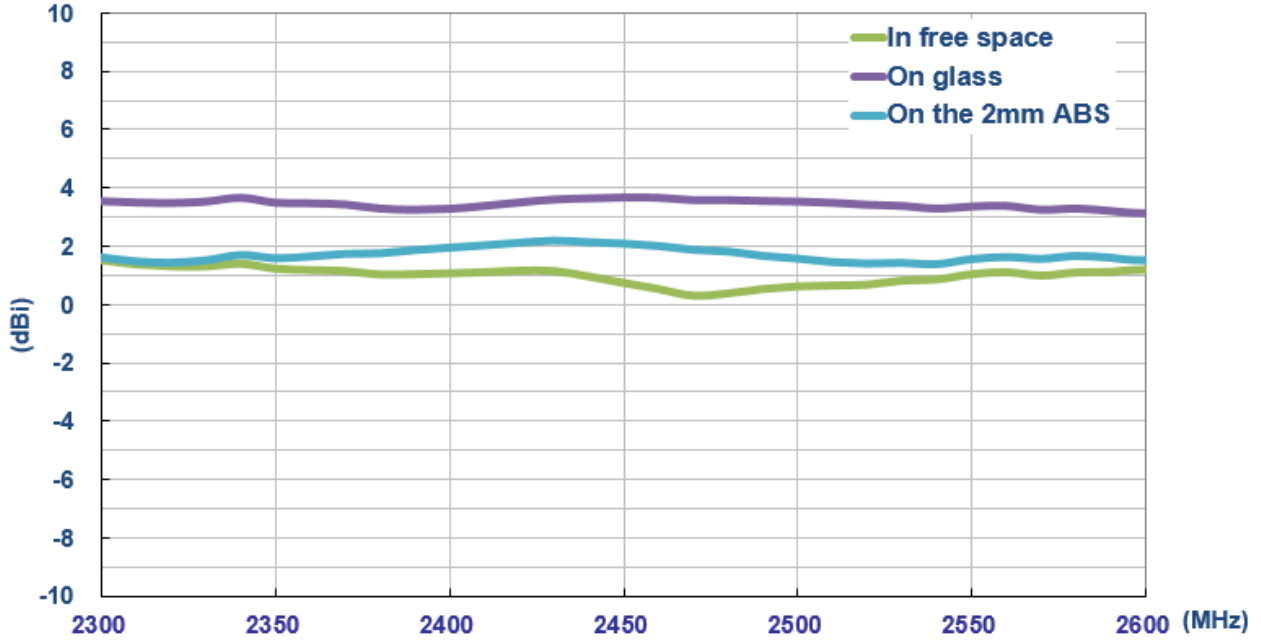

### 3.5 Average Gain

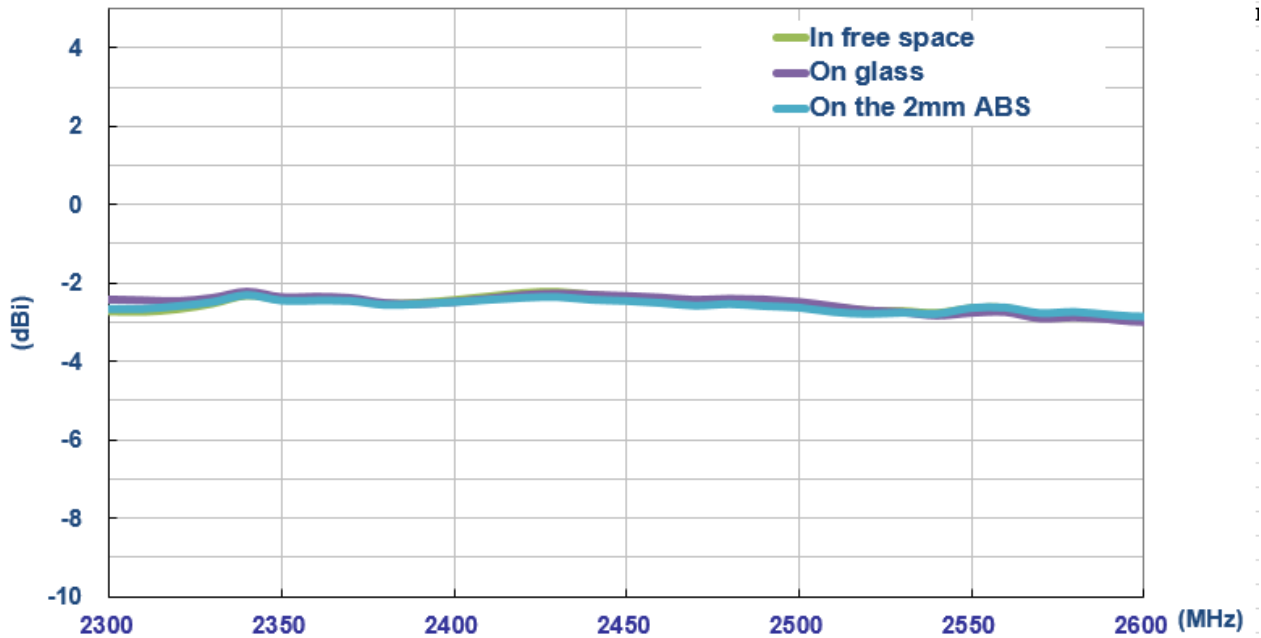

## 4. Antenna Radiation Patterns

### 4.1 Antenna Setup (Antenna testing Setup in ETS Anechoic Chamber)

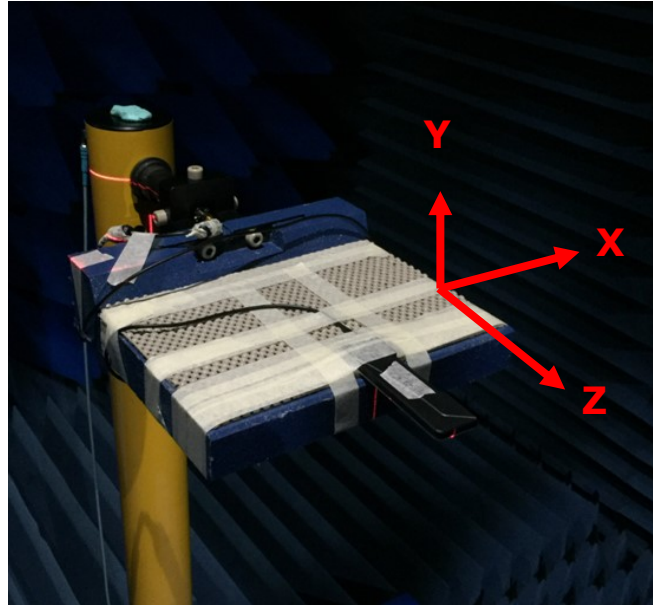

In free space

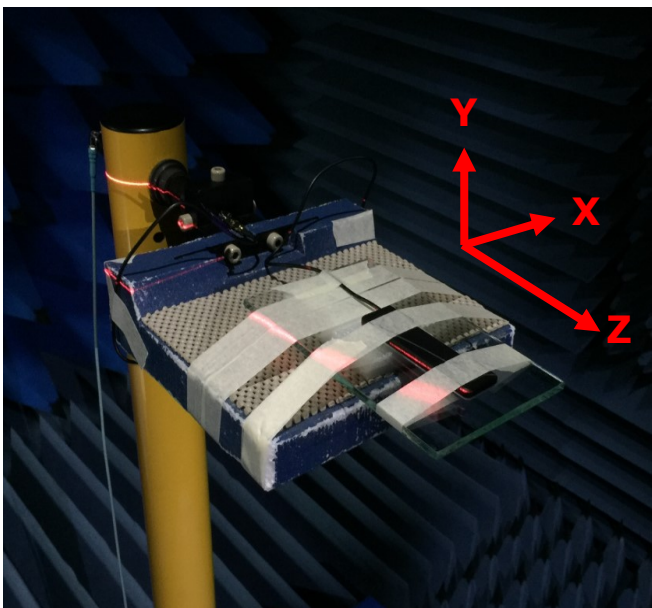

On glass

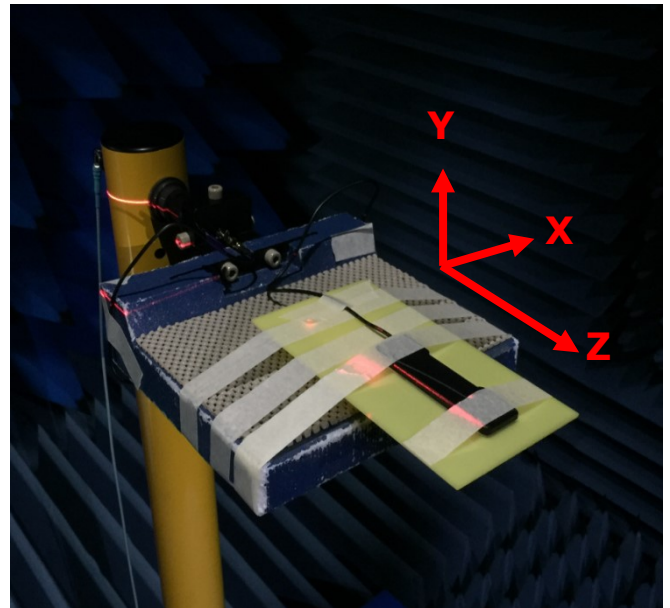

On the 2mm ABS



## 4.2 2D Radiation Patterns

### 4.2.1 In free space

XY Plane

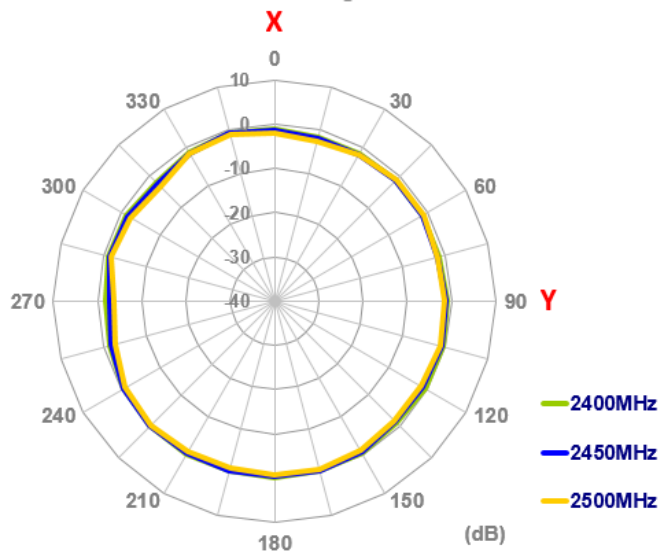

XZ Plane

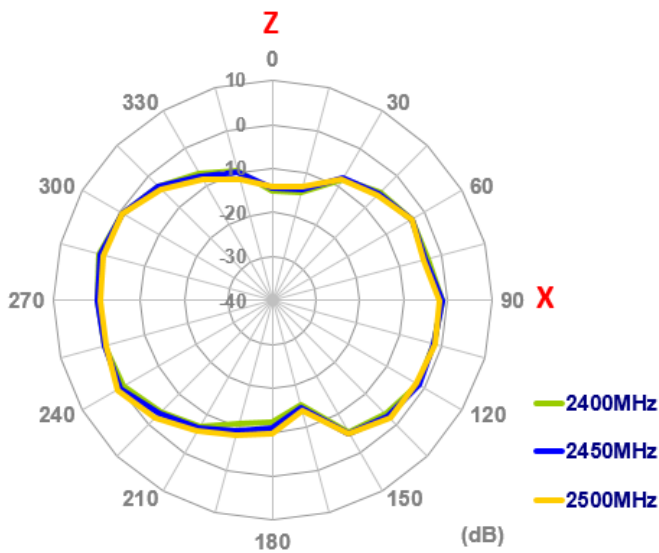

YZ Plane

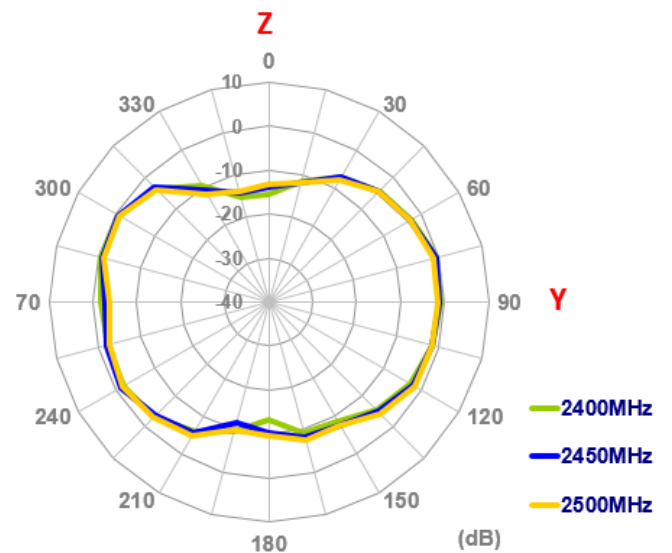

### 4.2.2 On glass

XY Plane

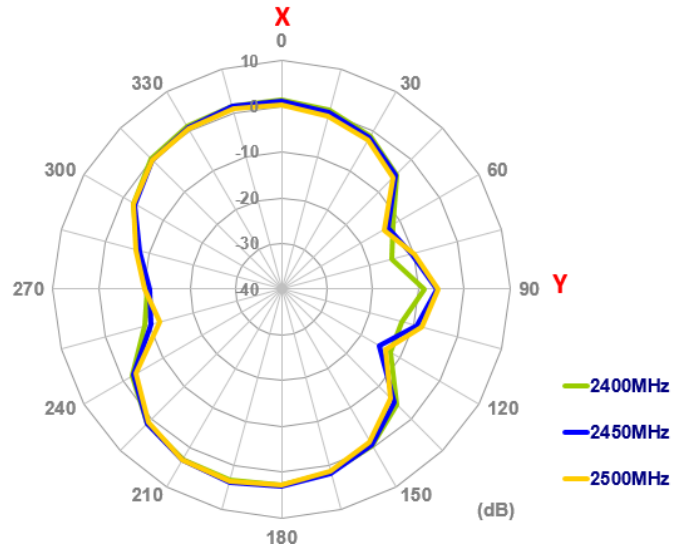

XZ Plane

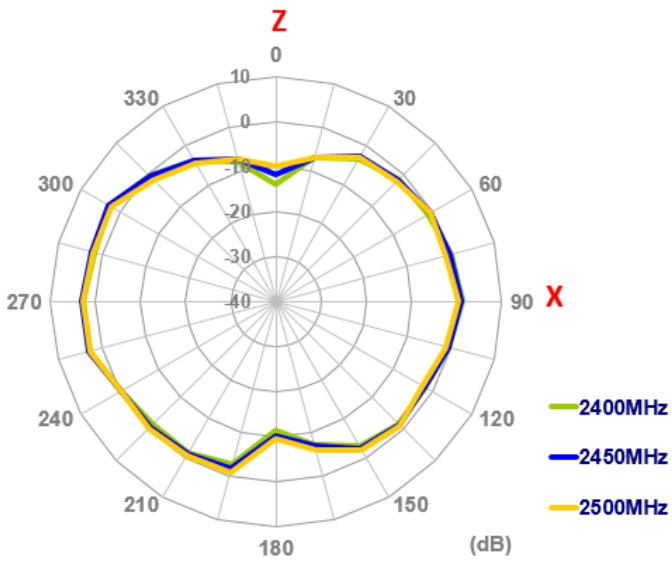

YZ Plane

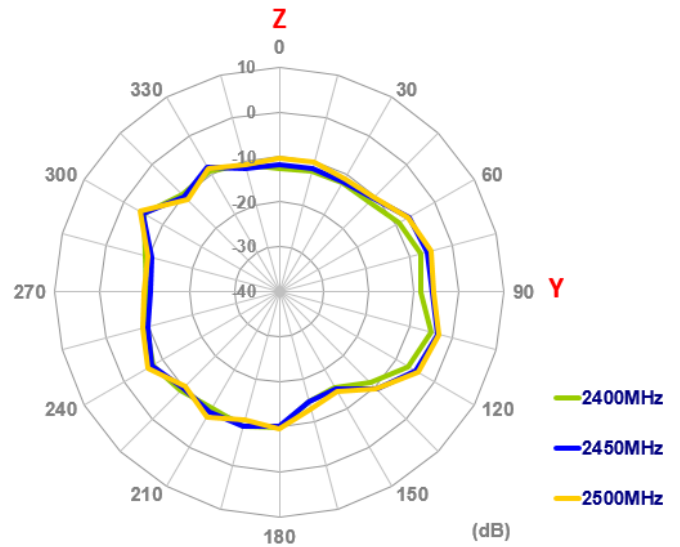

### 4.2.3 On the 2mm ABS

XY Plane

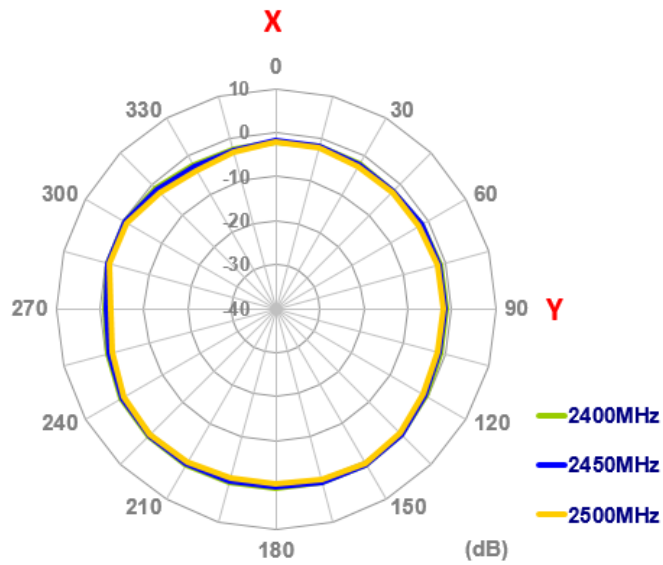

XZ Plane

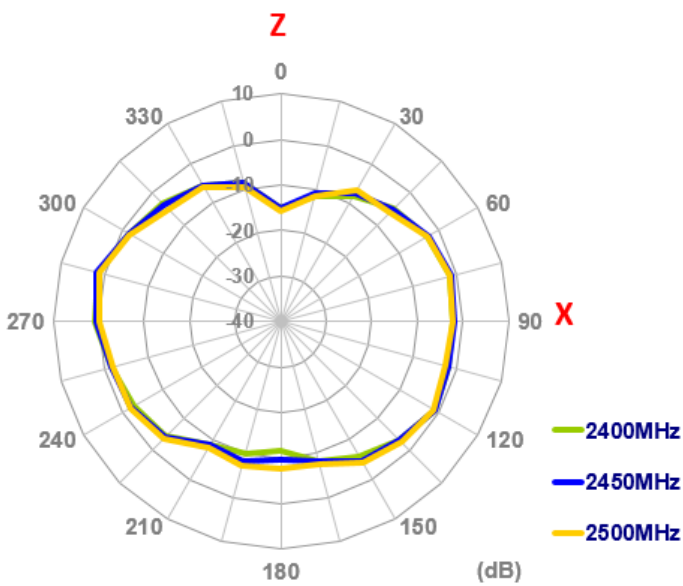

YZ Plane

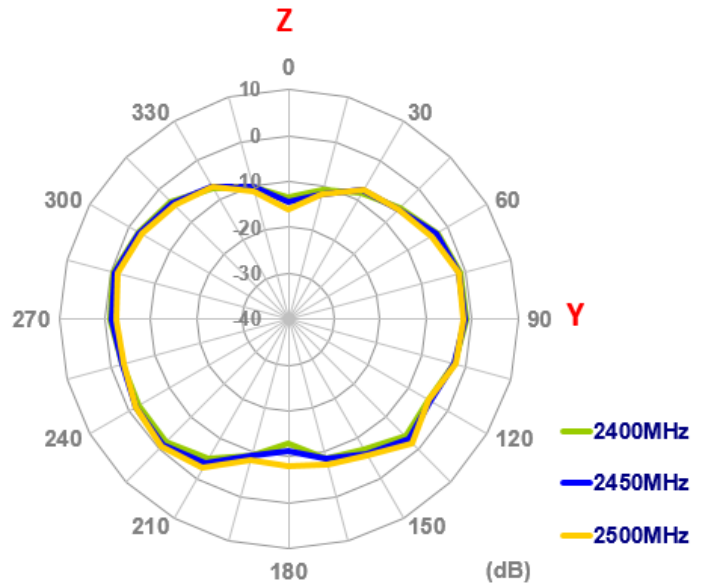

## 4.3 Antenna 3D Radiation Pattern

### 4.3.1 In free space

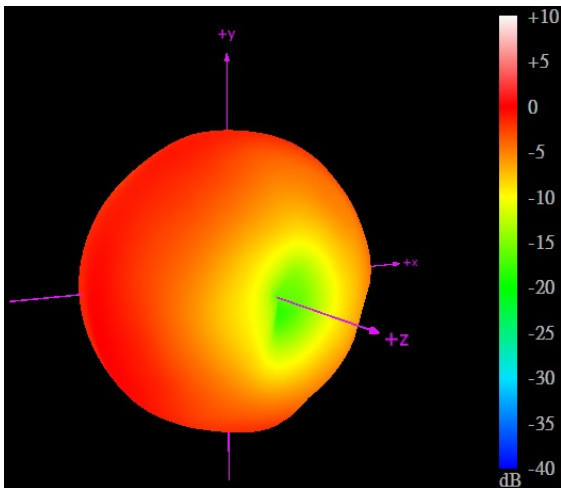

2400MHz

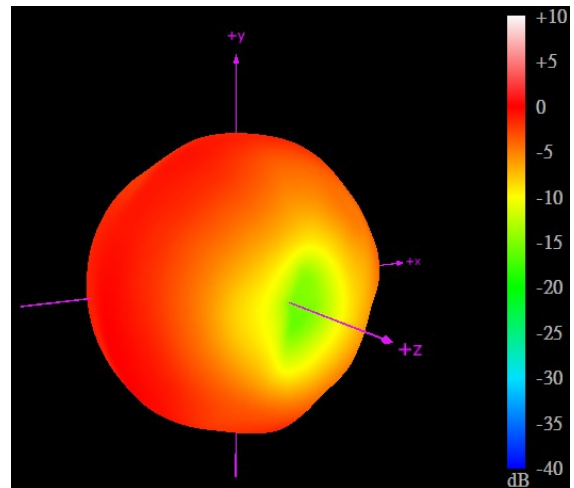

2450MHz

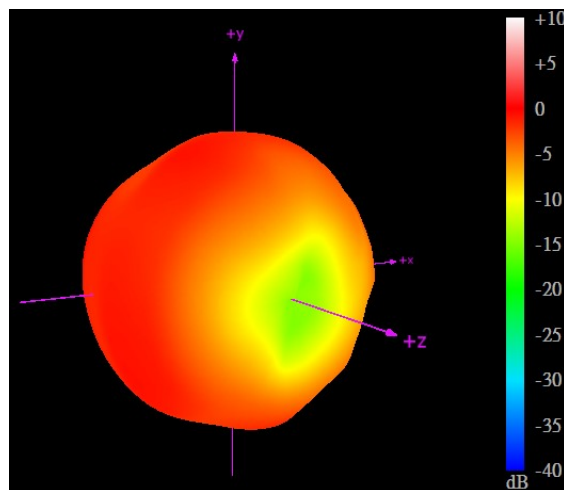

2500MHz

### 4.3.2 On glass

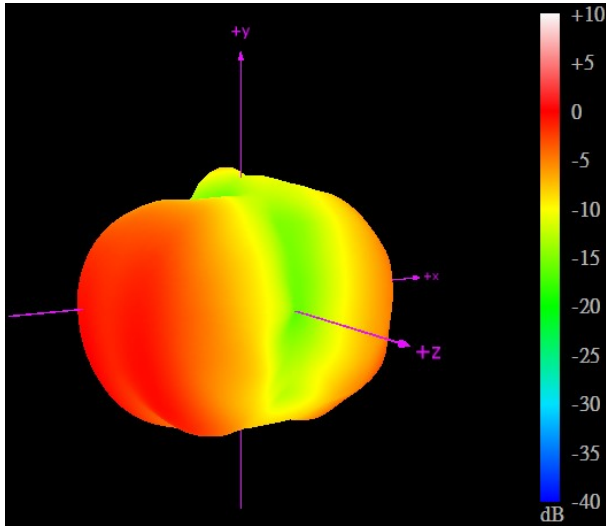

2400MHz

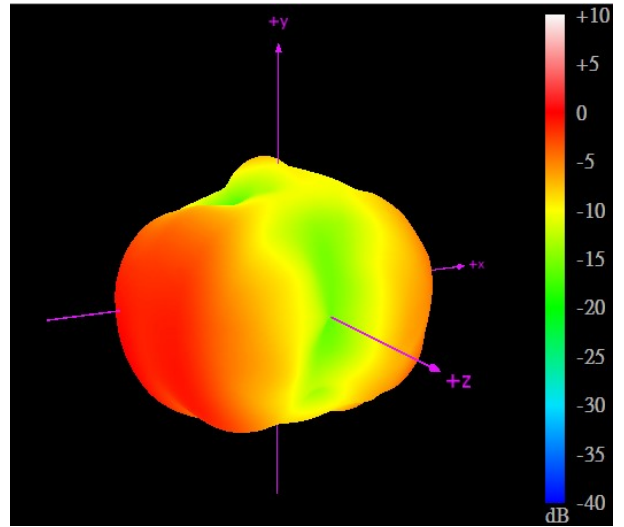

2540MHz

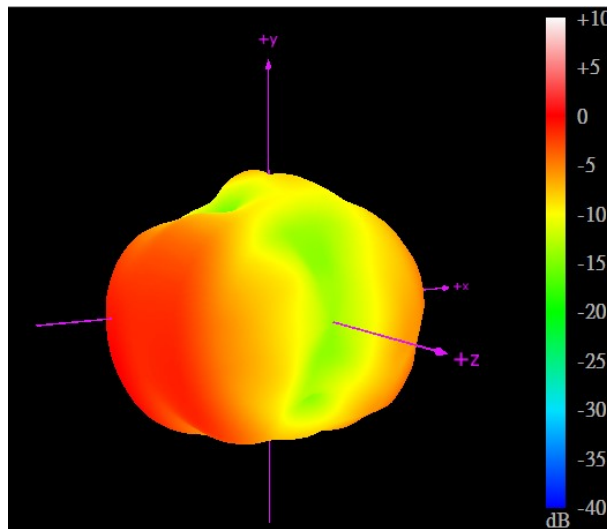

2500MHz

### 4.3.3 On the 2mm ABS

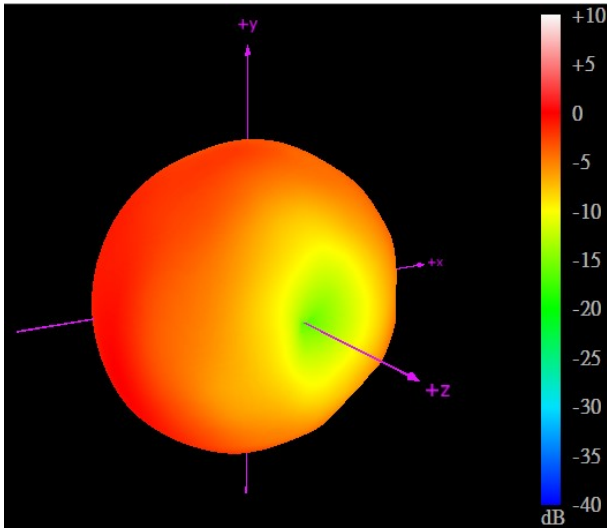

2400MHz

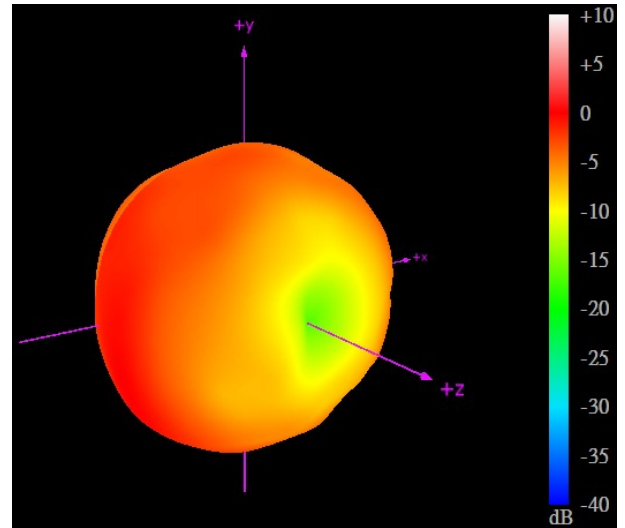

2540MHz

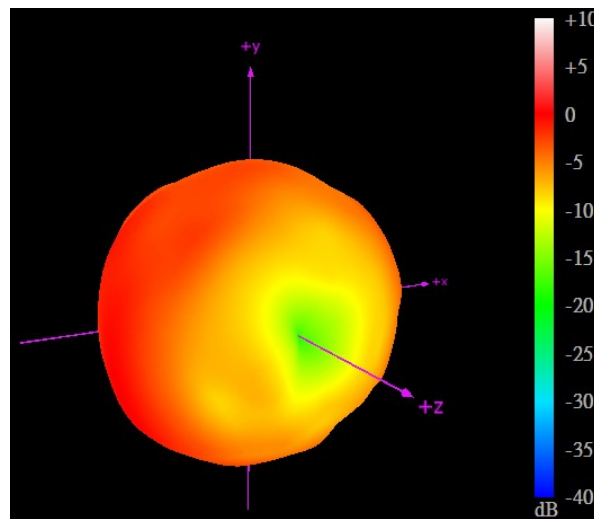

2500MHz

## 5. Drawing (Unit: mm)

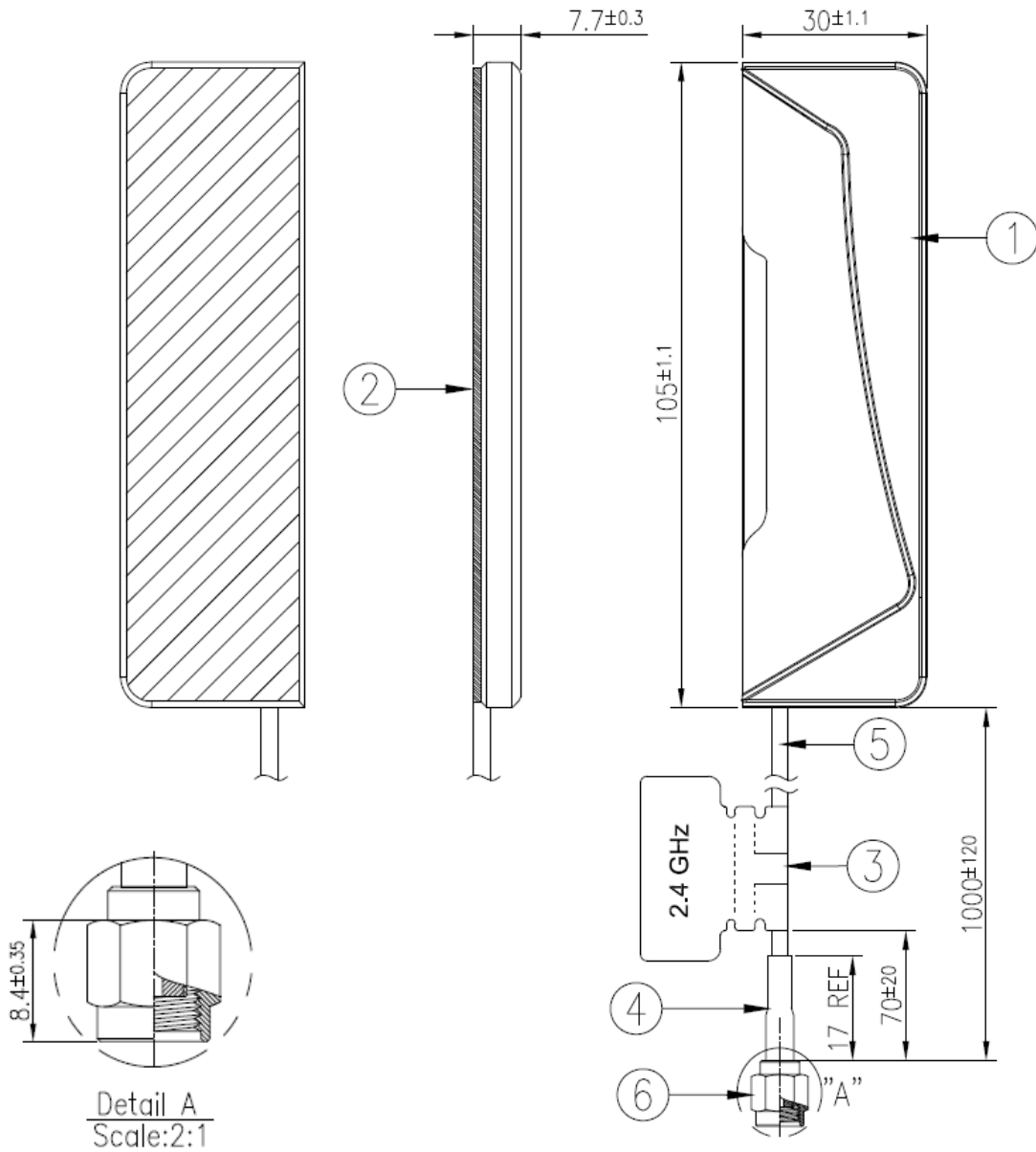

	Name	Material	Finish	QTY
1	Housing	PC+ABS	Black	1
2	Double Sided Adhesive	3M 1600T	Blue Liner	1
3	2.4 GHz Label	Coated Paper	Light Green	1
4	Heat Shrink Tube	PE	Black	1
5	RG174 Coaxial Cable	PVC	Black	1
6	RP-SMA(M)	Brass	Au Plated	1

## 6. Packaging

### Packaging Specifications

1pcs WSA.2400.A.101151 per PE Bag  
 Bag Dimensions - 70 x 80mm  
 Weight - 35g

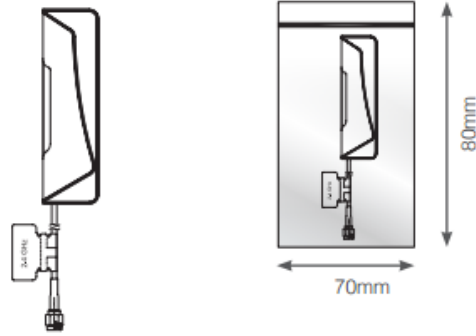

10 PE Bags per large PE Bags  
 10 pcs MA301.A.AB.001 per large PE Bag  
 large PE Bags Dimensions - 440 x 240mm  
 Weight - 0.44KG

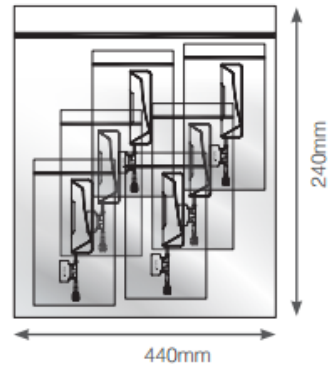

10 pcs WSA.2400.A.101151 per carton  
 Carton - 400 x 330 x 220mm  
 Weight - 5.2Kg

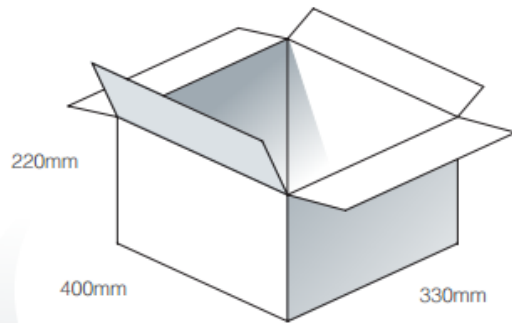

Pallet Dimensions 120 x 100 x 150cm  
 54 Cartons per Pallet  
 9 Cartons per layer  
 6 Layers

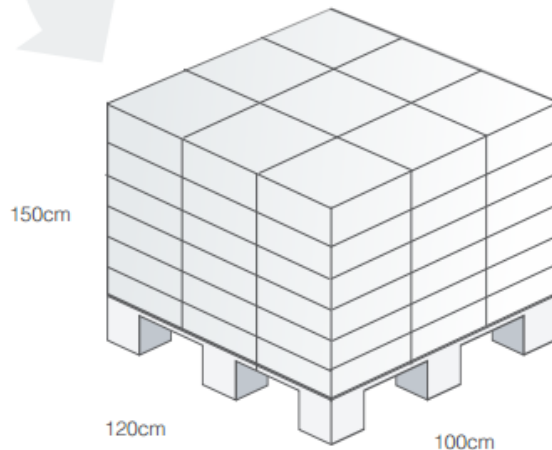



## 7. Application Note

Antenna performance versus cable length is shown below.

### 7.1 Return Loss

#### In free space

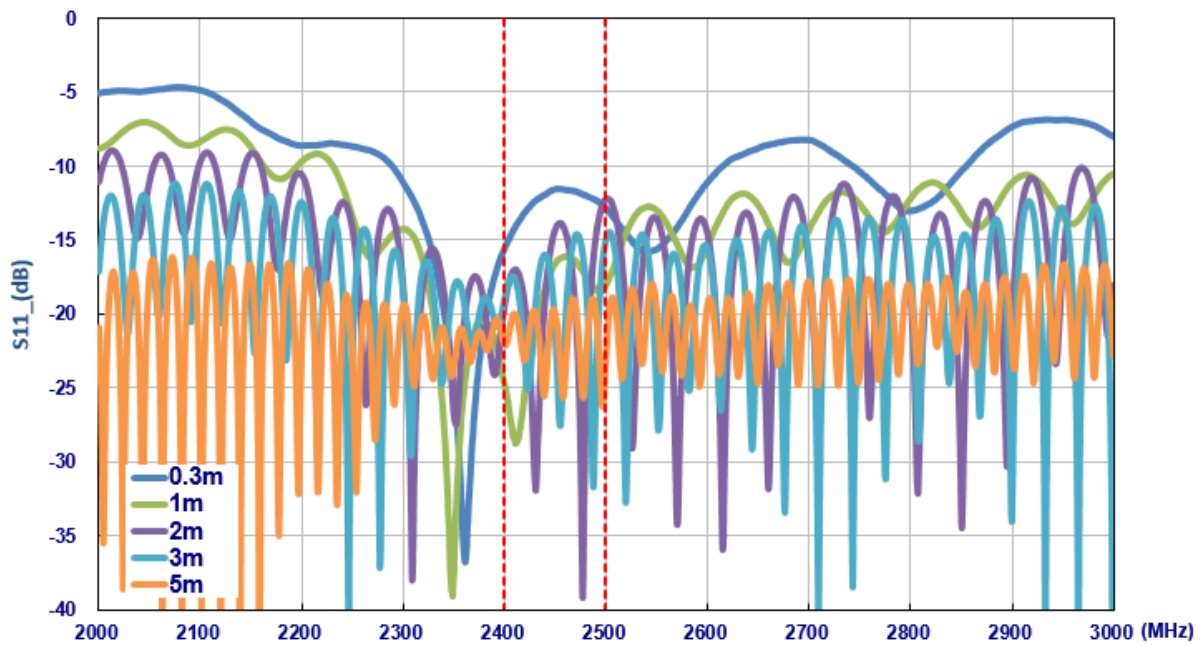

#### On glass

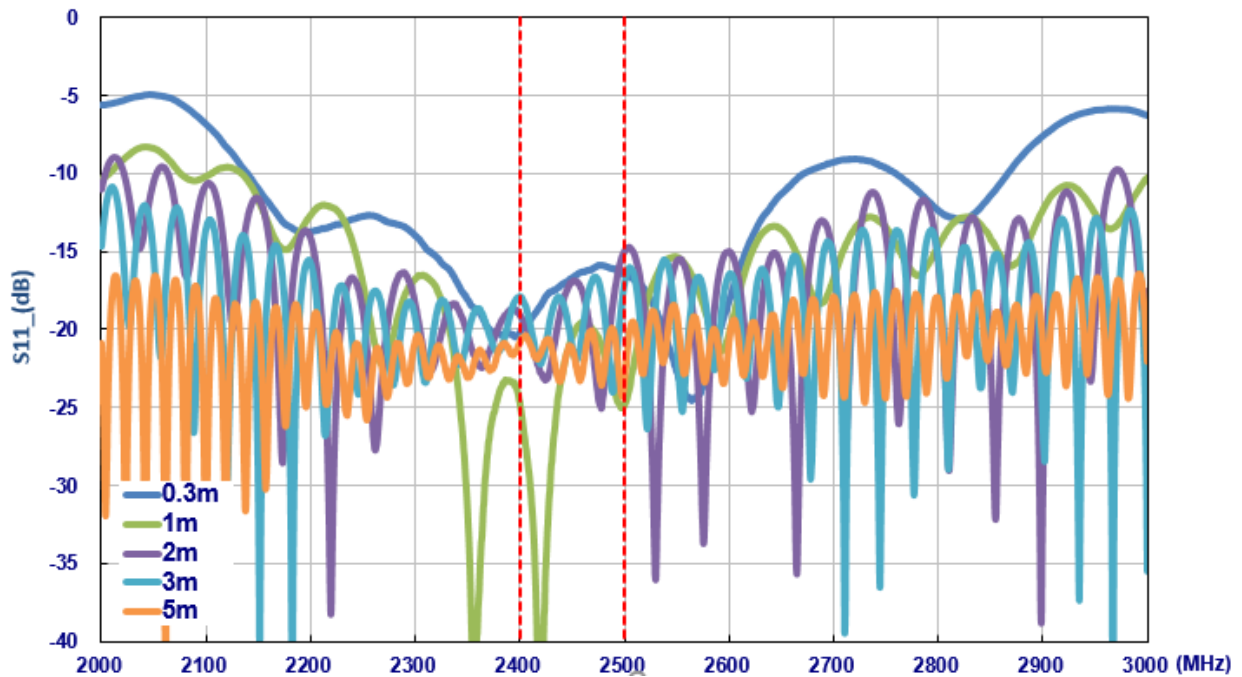

## On the 2mm ABS

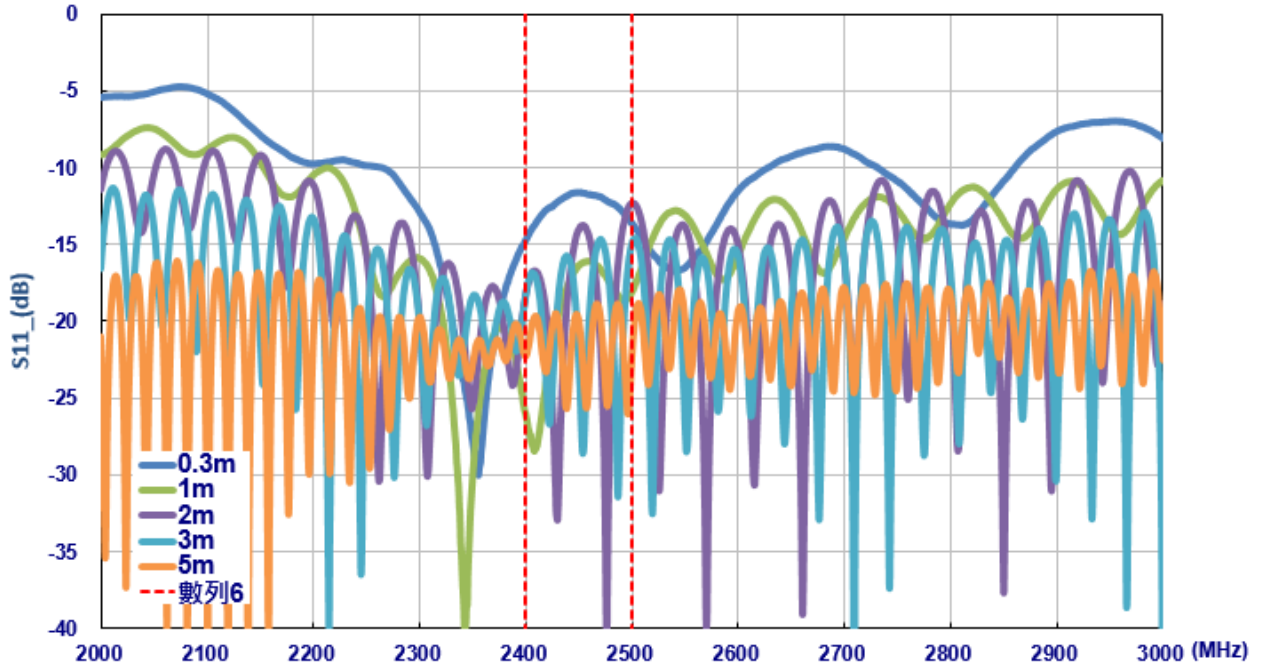

## 7.2 Efficiency

### In free space

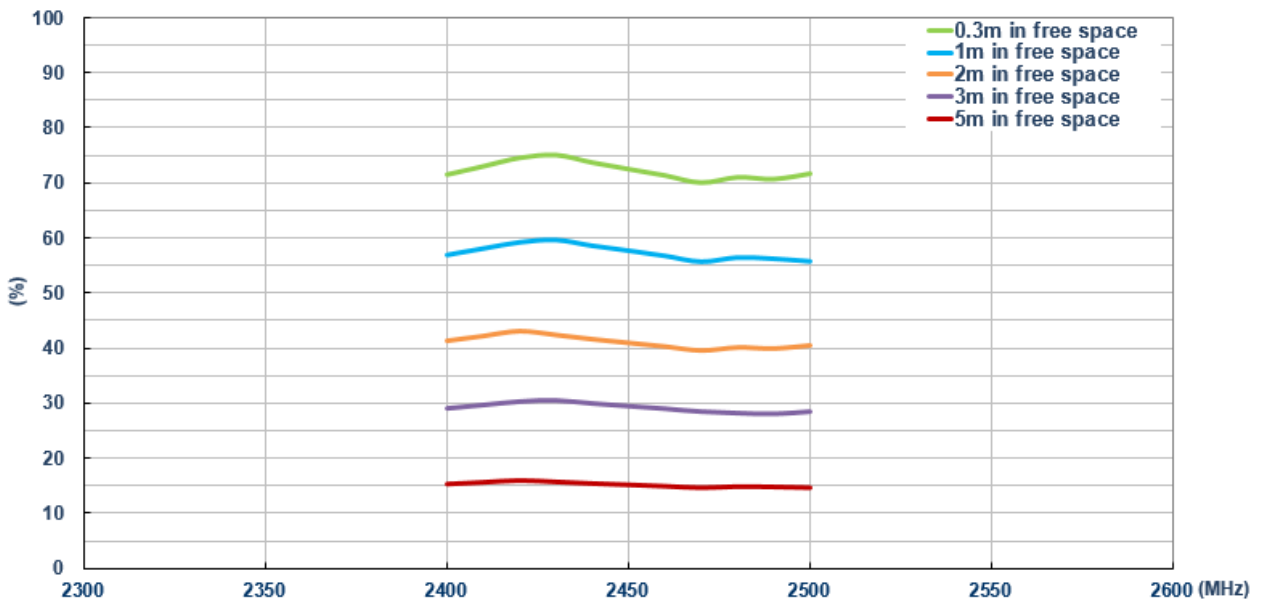

### On glass

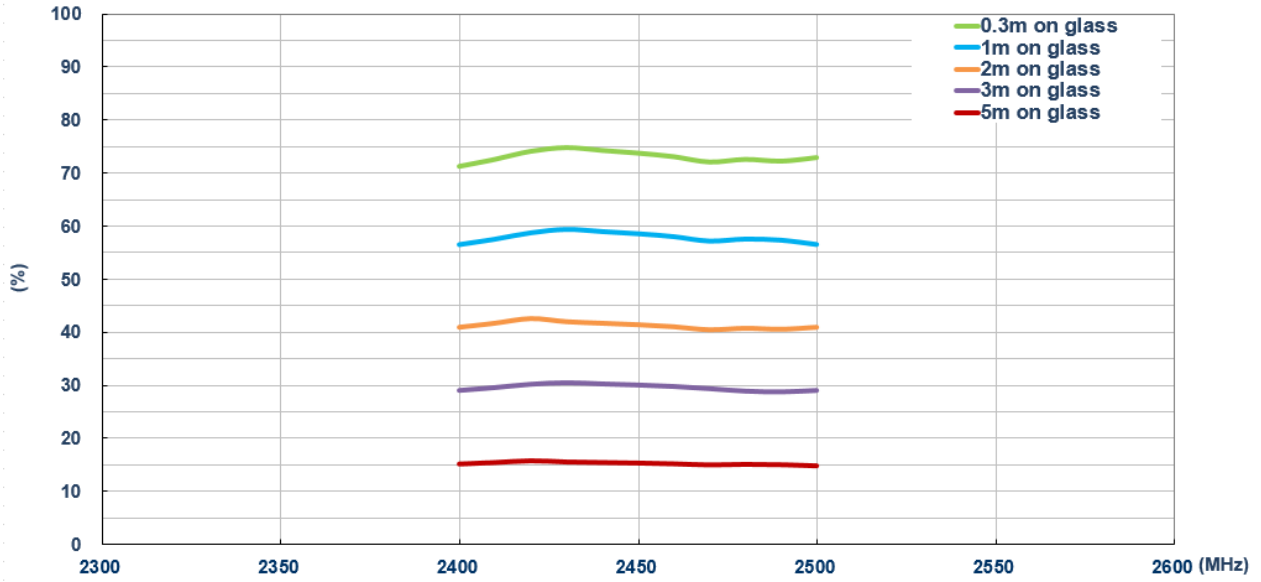

### On the 2mm ABS

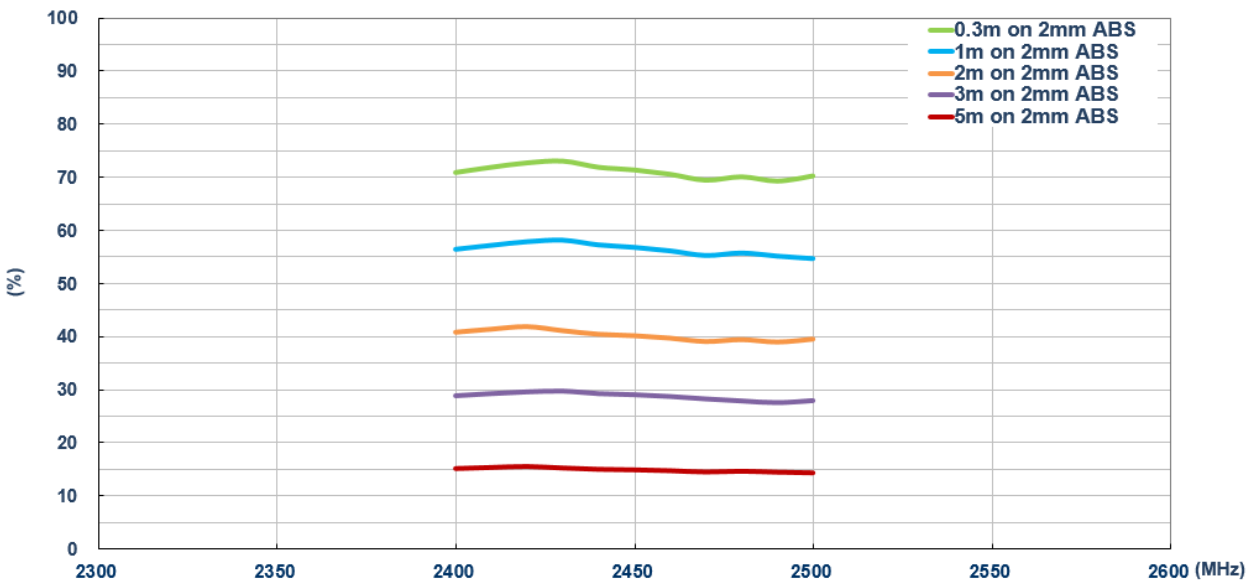

### 7.3 Peak Gain

#### In free space

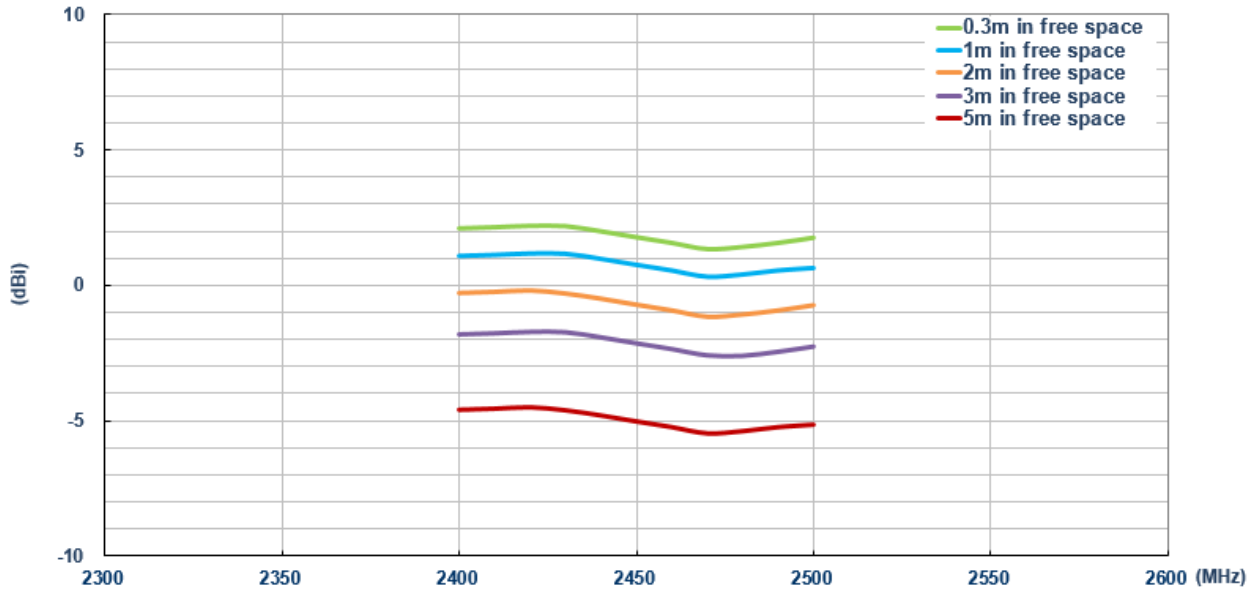

#### On glass

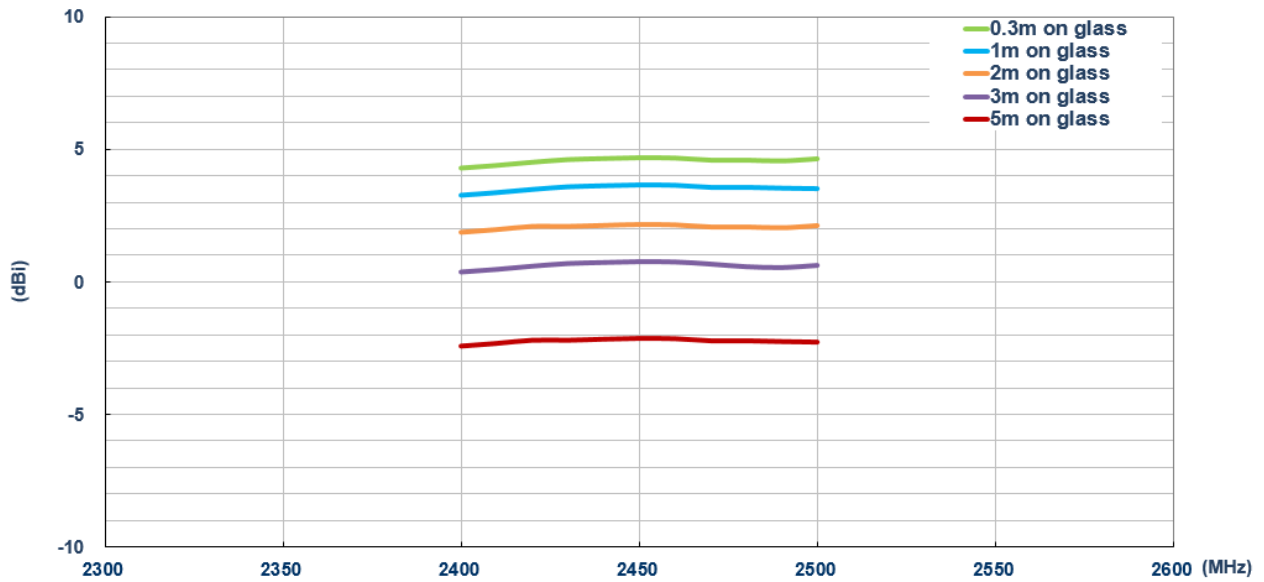

## On the 2mm ABS

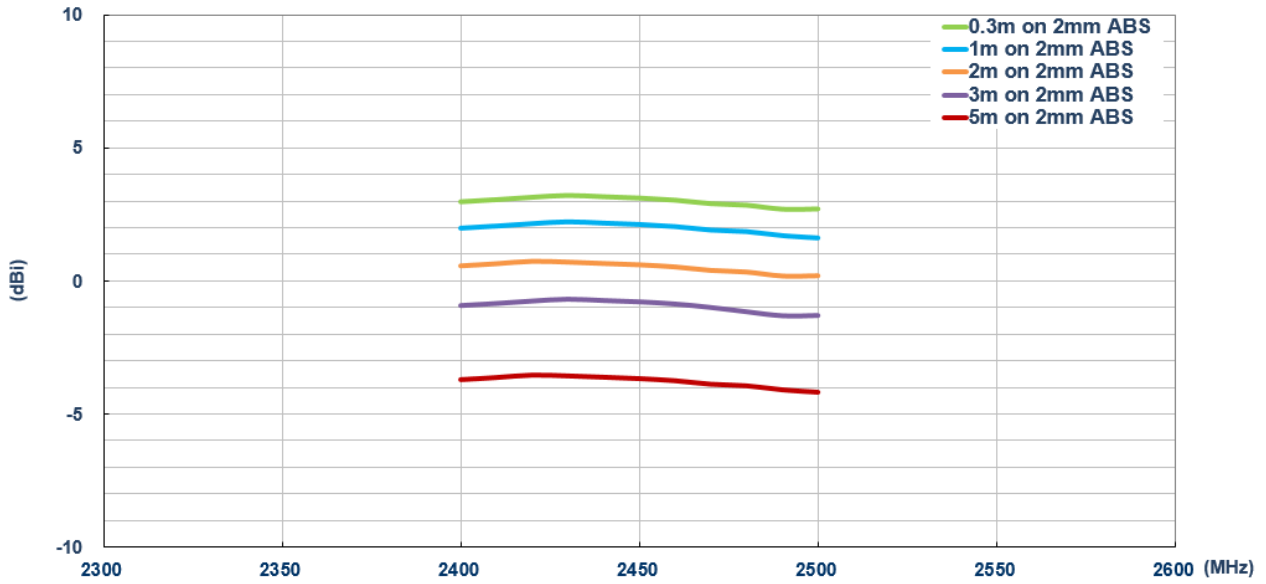

## 7.4 Average Gain

### In free space

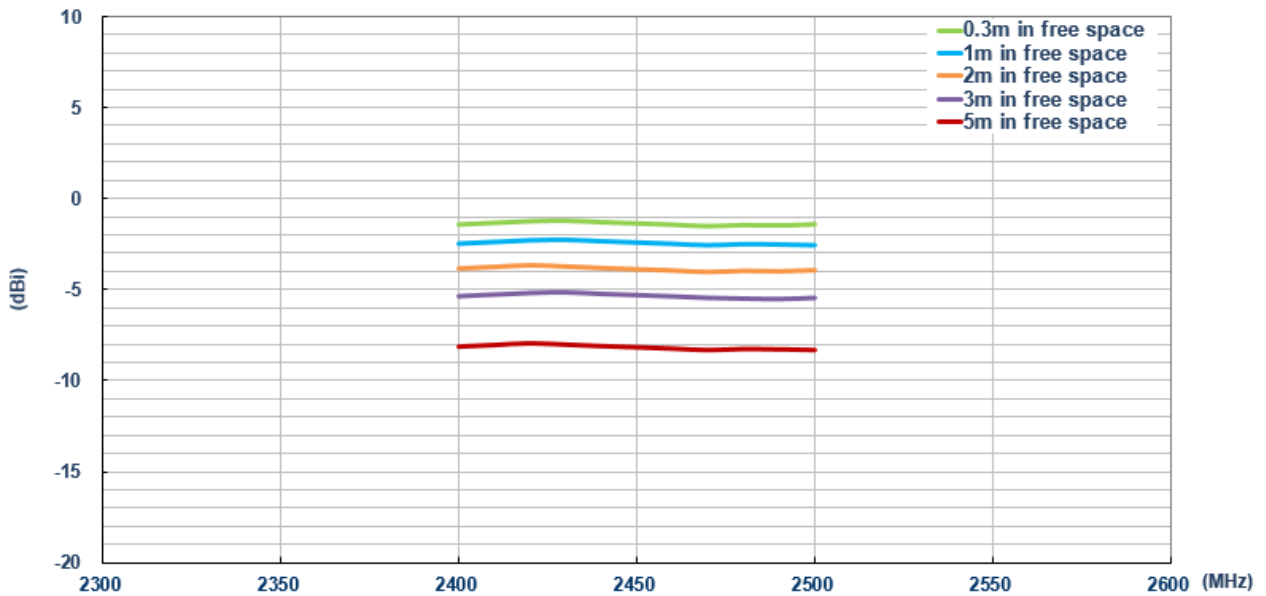

### On glass

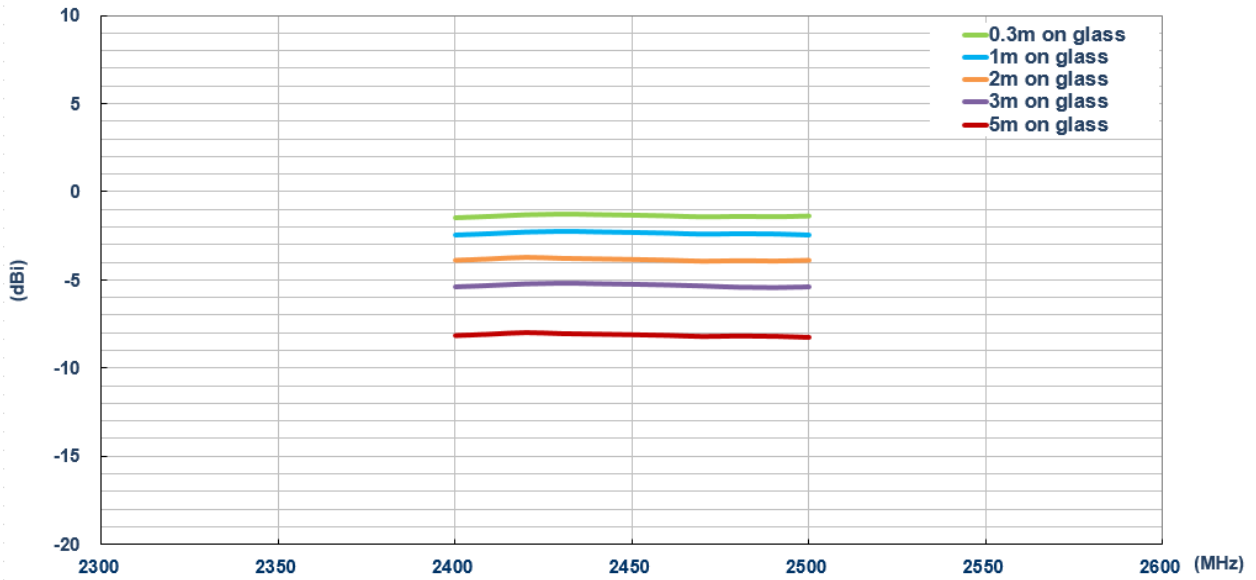

### On the 2mm ABS

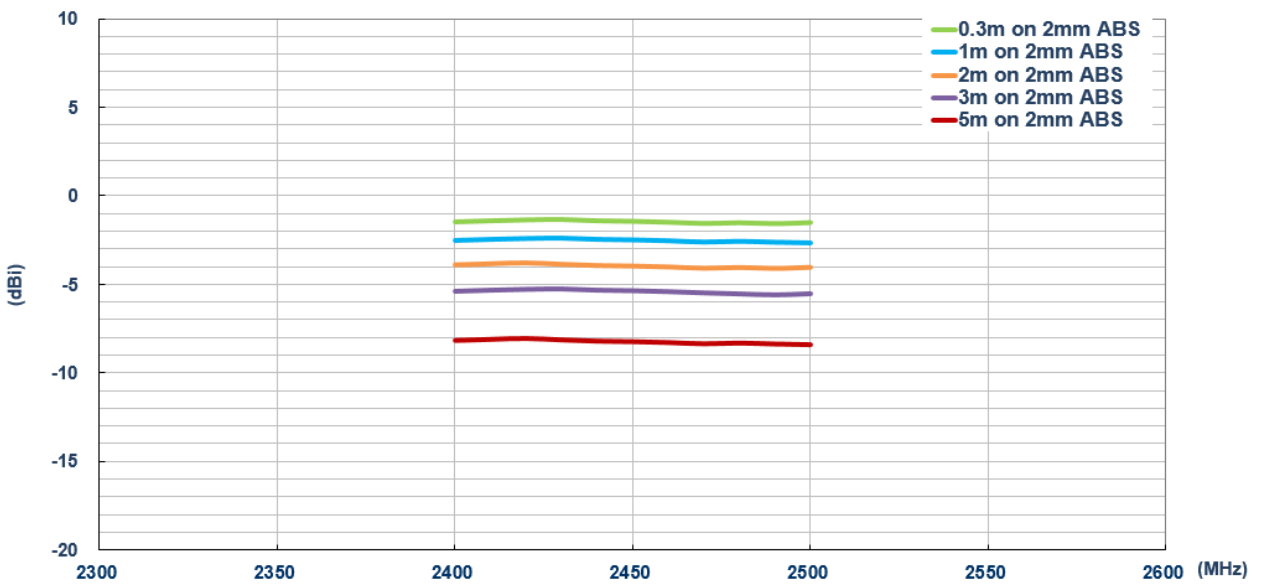

Taoglas makes no warranties based on the accuracy or completeness of the contents of this document and reserves the right to make changes to specifications and product descriptions at any time without notice. Taoglas reserves all rights to this document and the information contained herein.

Reproduction, use or disclosure to third parties without express permission is strictly prohibited.

Copyright © Taoglas Ltd.